

Product Description

LUX ELEMENTS®-ADD/FIX PRO-MAK are solid boards made of thermoplastic copolyester. They feature high impact resistance and a good fire protection classification as well as being food compatible and fully recyclable.

LUX ELEMENTS®-ADD/FIX PRO-MAK serves as a hard plastic insert which is stuck onto the hard foam where a stable mounting is required, for example for a door hinge. Screws can be simply screwed in. The hinges mounted in this way hold even heavy glass doors firmly.

Physical characteristics

Characteristics	Test acc. to	Unit	Result
Density	EN ISO 1183-1	g/cm ³	1,27
Moisture absorbance after storage in a normal climate (23 °C / 50 % R.H.)	EN ISO 62-4	%	0,2
Moisture absorbance after storage in water (at 23 °C up to saturation)	EN ISO 62-1	%	0,6
Yield stress	EN ISO 527-2/1B/50	MPa	> 45
Elongation at yield stress	EN ISO 527-2/1B/50	%	4
Tensile strength	EN ISO 527-2/1B/50	MPa	> 45
Elongation at tear	EN ISO 527-2/1B/50	%	> 35
Modulus of elasticity	EN ISO 527-2/1B/1	MPa	2.020
Limiting flexural stress	EN ISO 178	MPa	approx. 80
VICAT softening temperature	EN ISO 306, Method B50	°C	80
Thermal conductivity	DIN 52612	W/m K	0,2
Linear thermal coefficient of expansion	DIN 53752-A	mm/m K	0,05
Fire class	EN 13501-1		B-s1, d0
Fire resistance	DIN 4102		B 1, flame resistant
Temperature resistance	—	°C	-40 / + 65 no load

The data are guiding values and may change according to the processing method and preparation of test specimens. The mechanical properties are average values of measurements performed on extruded boards with a thickness of 4 mm.

The data cannot be transferred as they are to prefabricated parts. The processor or user must check the suitability of the material for a specific purpose of use. The technical characteristic values are merely a planning aid. In particular, they do not represent guaranteed properties.

Further information can be obtained from our Technical Department.

The relevant recommendations and guidelines, as well as DIN regulations, European standards and safety datasheets are to be observed. The recognised architectural and technical rules apply. We accept liability for the perfect quality of our products. Our processing recommendations are based upon trials and practical experience; they can, however, be no more than general instructions without assurance as to their quality, since we have no influence on the site conditions, on the execution of the work and the processing. With the issuing of this product datasheet previous versions cease to be valid.

LUX ELEMENTS GmbH & Co. KG

An der Schusterinsel 7
D - 51379 Leverkusen-Opladen
Tel. +49 (0) 21 71/72 12-0
Fax +49 (0) 21 71/72 12-40
E-Mail info@luxelements.de

LUX ELEMENTS S.A.S

Z1-31, rue d'Ensisheim
F - 68190 Ungersheim
Tél. +33 (0) 3 89 83 69 79
Fax +33 (0) 3 89 48 83 27
E-Mail info@luxelements.fr

LUX ELEMENTS®-ADD/FIX PRO-MAK ...

Benötigte Werkzeuge · Tools required · Outils requis · Benodigd gereedschappen

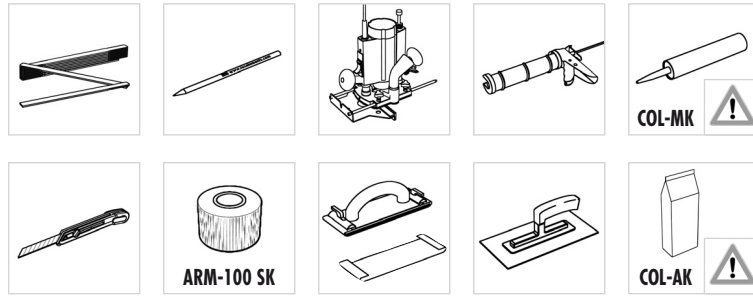

LUX ELEMENTS®-COL-MK

[DE] - Augen- und Gesichtsschutz tragen
[EN] - Wear eye and face protection
[FR] - Porter équipement de protection des yeux/du visage
[NL] - Oog- en gelaatsbescherming dragen

LUX ELEMENTS®-COL-AK

[DE] - Schutzhandschuhe/-kleidung, Augen- und Gesichtsschutz tragen
[EN] - Wear protective gloves/clothing, eye and face protection
[FR] - Porter des gants/vêtements de protection, équipement de protection des yeux/du visage
[NL] - Beschermende handschoenen/kleding, oog- en gelaatsbescherming dragen

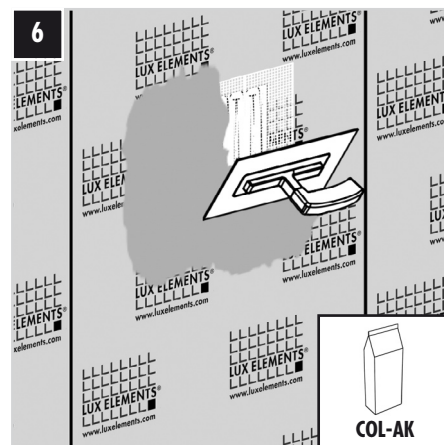
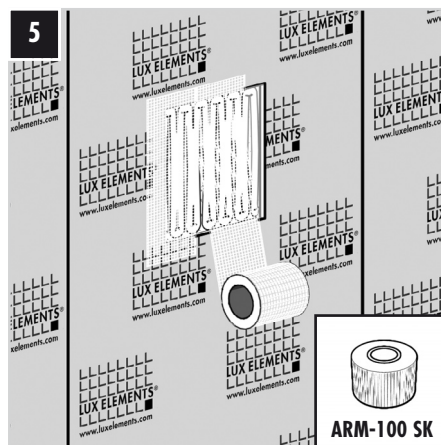
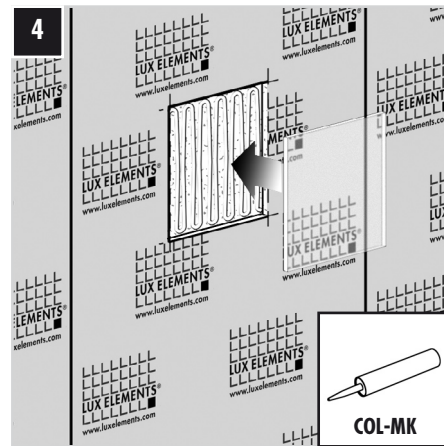
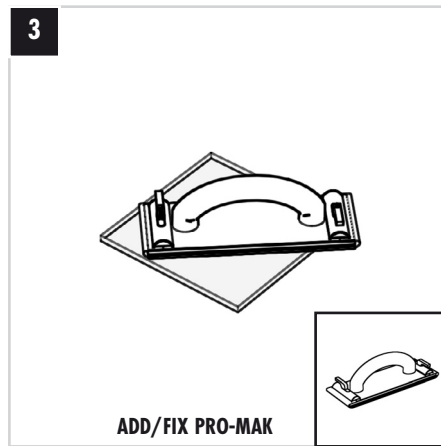
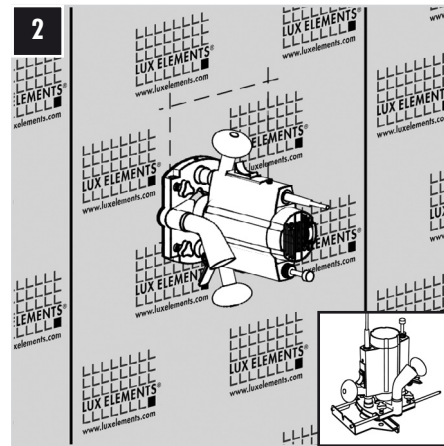
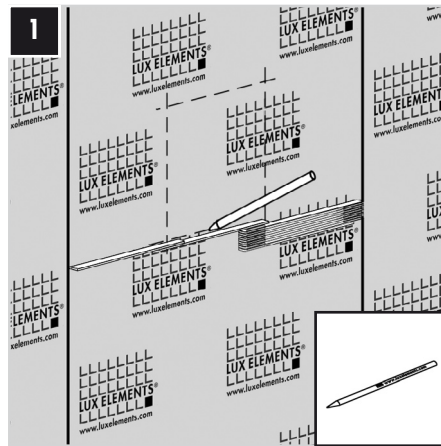

[DE] – **Hinweis:** Bei Verschraubungen mit passendem Bohrer vorbohren
[EN] – **Please note:** For screw connections, pre-drill with a suitable drill

[FR] – **Remarque :** Pour les raccords vissés, pré-percer avec un foret adapté
[NL] – **Let op:** Voor schroefverbindingen voorboren met een geschikte boor